

RPC-1MC-UNI

time relays



RPC-1MC-UNI

- **Immediate activation of the selected function**
- without having to temporarily turn off the power supply

- **Multifunction time relays (14 time functions; 8 time ranges)**
- Cadmium - free contacts 1 CO • AC/DC input voltages
- Cover - modular, width 17,5 mm • Direct mounting on 35 mm rail mount acc. to EN 60715 • Applications: in low-voltage systems
- Compliance with standard EN 61812-1
- Recognitions, certifications, directives: RoHS,

Output circuit - contact data

Number and type of contacts		1 CO
Contact material		AgSnO ₂
Max. switching voltage		300 V AC
Rated load	AC1	16 A / 250 V AC
	DC1	16 A / 24 V DC 0,3 A / 250 V DC
Rated current		16 A / 250 V AC
Max. breaking capacity	AC1	4 000 VA
Min. breaking capacity		1 W 10 mA
Contact resistance		≤ 100 mΩ
Max. operating frequency		600 cycles/hour at rated load AC1
Input circuit		
Rated voltage	AC: 50/60 Hz AC/DC	12...240 V terminals (+)A1, (-)A2
Must release voltage		≥ 0,1 U _n
Operating range of supply voltage		0,9...1,1 U _n
Rated power consumption	DC	≤ 1,5 W
Range of supply frequency	AC	48...63 Hz
Control contact S	• min. voltage	0,7 U _n
	• min. time of pulse duration	AC: ≥ 50 ms DC: ≥ 30 ms
	• max. length of control line	10 m
Insulation according to EN 60664-1		
Insulation rated voltage		250 V AC
Rated surge voltage		4 000 V 1,2 / 50 μs
Overvoltage category		III
Insulation pollution degree		2
Flammability class		V-0 for modular cover, UL 94
Dielectric strength	• input - output	4 000 V AC type of insulation: basic
	• contact clearance	1 000 V AC type of clearance: micro-disconnection
General data		
Electrical life	• resistive AC1	> 0,5 x 10 ⁵ 16 A, 250 V AC
Mechanical life (cycles)		> 3 x 10 ⁷
Dimensions (L x W x H)		90 x 17,5 x 64,6 mm
Weight		65 g
Ambient temperature	• storage	-40...+70 °C
(non-condensation and/or icing)	• operating	-20...+50 °C
Cover protection category		IP 20 EN 60529
Relative humidity		up to 85%
Shock / vibration resistance		15 g / 0,35 mm DA 10...55 Hz
Time module data		
Functions		E, E(S), Wu, Wu(S), Bp, Bp(S), Bi, Bi(S), R, Ws, Wa, Esa(R), E(R), Wu(R)
Time ranges		OFF - permanent switching off; ON - permanent switching on 1 s ; 10 s; 1 min.; 10 min.; 1 h; 10 h; 1 d; 10 d
Timing adjustment		smooth - (0,1...1) x time range (does not refer to range ON / OFF)
Setting accuracy		± 5%
Repeatability		± 0,5%
Values affecting the timing adjustment		temperature: ± 0,05% / °C supply voltage: ± 0,01% / V
Recovery time		AC: ≤ 400 ms DC: ≤ 150 ms
LED indicator		green LED U ON - indication of supply voltage U green LED U flashing - measurement of T time yellow LED R ON/OFF - output relay status

The control terminal S is activated by connection to A1 terminal via the external control contact S. Where the control signal is recognizable.
 Length with 35 mm rail catches: 98,8 mm. For first range setpoint (1 s) setting accuracy and repeatability are smaller than the given ones in technical parameters (significant influence of the operational relay operating time, processor start-time, and the moment of supply switching as referred to the AC supply course). Calculated from the final range values, for the setting direction from minimum to maximum.

Time functions

E - ON delay.

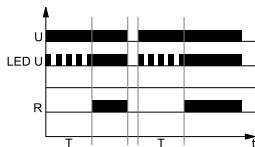

On applying the supply voltage U the set interval T begins - off-delay of the output relay R. After the interval T has lapsed, the output relay R switches on and remains on until supply voltage U is interrupted.

E(S) - ON delay, with time measurement stopped with contact S.

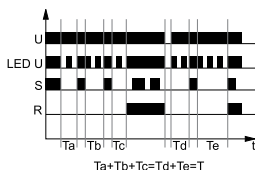

On applying the supply voltage U the set interval T begins. If during measuring time T control contact S is closed, measuring of time T is stopped for the time of closing contact S. Opening of control contact S resumes measuring of time T. After finishing measuring time T, the output relay R switches on and remains on until supply voltage U is interrupted.

Wu - ON for the set interval.

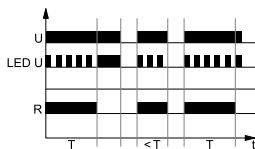

Applying the supply voltage U immediately switches the output relay R on for the set interval T. After the interval T has lapsed, the output relay R switches off.

Wu(S) - ON for the set interval, with time measurement stopped with closing of contact S.

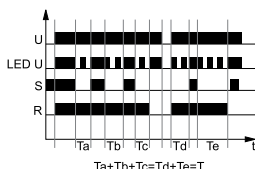

Applying the supply voltage U immediately switches the output relay R on for the set interval T. If the control contact S is closed, the interval T measurement will be stopped until the moment when control contact is opened. Opening contact S starts further measuring of time T. After finishing measuring time T, the output relay R switches off.

Bp - Symmetrical cyclical operation pause first.

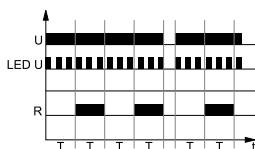

Applying the supply voltage U starts the cyclical operation from the interval T - switching the output relay R off followed by switching on the output relay R for the interval T. The cyclical operation lasts until the supply voltage U is interrupted.

U - supply voltage; R - output state of the relay; S - control contact state; T - measured time; t - time axis

Bp(S) - Symmetrical cyclical operation pause first, with interval T measurement stopped for the time the S contact is switched on.

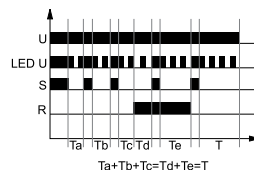

Applying the supply voltage U starts the cyclical operation from the interval T - switching the output relay R off. If in the course of measurement of interval T the control contact S is closed, the measurement of the time of switching off the R relay will be interrupted for the time the S contact remains closed. Opening of the control contact S triggers further measurement of the interval T. After the interval T has lapsed, the output relay R switches on for the set interval T. If during the measurement of the time of switching on the R relay will be interrupted for the time the S contact remains closed. Opening of the control contact S triggers further measurement of the interval T. The cyclical operation lasts until the supply voltage U is interrupted.

Bi - Symmetrical cyclical operation pulse first.

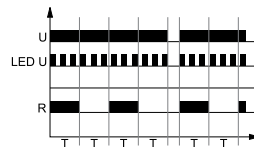

Applying the supply voltage U starts the cyclical operation from switching on the output relay R for the set interval T. After the interval T has lapsed, the output relay R switches off for the interval T. The cyclical operation lasts until the supply voltage U is interrupted.

Bi(S) - Symmetrical cyclical operation pulse first, with interval T measurement stopped for the time the S contact is switched on.

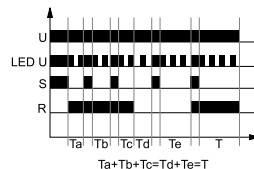

Applying the supply voltage U starts cyclical operation from measurement of the interval T - switching on the output relay R. If in the course of measurement of interval T the control contact S is closed, the measurement of the time of switching off the R relay will be interrupted for the time the S contact remains closed. Opening of the control contact S triggers further measurement of the interval T. After the interval T has lapsed, the output relay R switches on for the set interval T. If during the measurement of the interval T the control contact S is closed, measurement of the time of switching off the R relay will be interrupted for the time the S contact remains closed. Opening of the control contact S triggers further measurement of the interval T. The cyclical operation lasts until the supply voltage U is interrupted.

R - OFF delay with the control contact S.

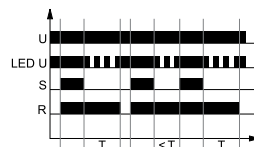

The input of the time relay is supplied with voltage U continuously. Closing of the control contact S immediately switches on the output relay R. Opening of the control contact S starts the set time of the delayed switching off of the output relay R. After the interval T has lapsed, the output relay R switches off. If the control contact S is closed during the interval T, the already measured time is reset, and the output relay R is switched on again. The OFF delay of the output relay R will start when the control contact S is opened again.

Time functions

Ws - Single shot for the set interval triggered by closing of the control contact S.

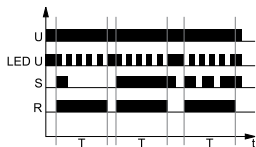

The input of the time relay is supplied with voltage U continuously. Closing of the control contact S immediately switches the output relay R on for the set interval T. After the interval T has lapsed, the output relay R is switched off. In the course of the interval T, any opening of the control contact S does not affect the function to be performed. The output relay R may be switched on again for the set interval, after the interval T has lapsed, by closing the control contact S again.

Wa - ON for the set interval triggered with the control contact S.

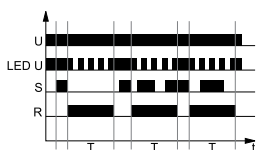

The input of the time relay is supplied with voltage U continuously. Closing of the control contact S does not start the interval T, and it does not change the position of the output relay R. Opening of the control contact S immediately switches on the output relay R for the set time. After the interval T has lapsed, the output relay R switches off. Opening and closing of the control contact S in the course of the interval T does not affect the function to be performed. The output relay R may be switched on again for the set interval with another closing and opening of the control contact S.

Esa(R) - ON and OFF delay controlled with on and off of the S contact with the Reset function.



The input of the time relay is supplied with voltage U continuously. Closing of the control contact S begins the measurement of the set interval T - ON delay of the output relay R. If the control contact S is opened during the measurement of the interval T - ON delay of the output relay R, the measured time will be reset. The interval T measurement will start after the control contact S has been closed. After the set interval T has lapsed,

the output relay R switches on. Opening of the control contact S will again trigger measurement of the set interval T - OFF delay of the output relay R, and after the interval has been measured, the output relay R switches off. If the control contact S is closed during the interval T measurement, the measured time will be reset. Opening of the control contact S will again trigger measurement of the interval T.

E(R) - ON delay with the Reset function.

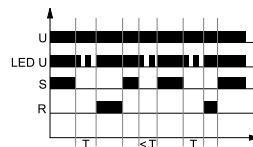

On applying the supply voltage U the set interval T begins. After the interval T has lapsed, output relay R turns on. If control contact S is closed during the measurement of interval T, measuring of interval T is stopped for the time the S contact remains closed. After opening contact S, time T is measured from the start. After the interval T has lapsed, the output relay R switches on until the moment of turning off supply voltage U or when the control contact S is closed again.

Wu(R) - ON for the set interval with the Reset function.



Applying the supply voltage U immediately switches the output relay R on for the set interval T. When control contact S is closed, measurement of the interval T is stopped for the time of closing contact S (with output relay R on). After opening contact S, time T is measured from the beginning. After the interval T has lapsed, the output relay R switches off.

ON / OFF - Permanent switching on / off.

The functions ON and OFF are selected with T time range adjusting knob. In the ON function, the normally open contacts are closed all the time whereas in the OFF function they are open. The position of the function -adjusting knob is of no significance in these functions as is the preset measurement time. The ON or OFF functions are used for the time relay operation control in electric systems.

U - supply voltage; R - output state of the relay; S - control contact state; T - measured time; t - time axis

Additional functions

Supply diode: it is lit permanently when the time is not being measured. In course of the T time measurement, it flashes at 500 ms period where it is lit for 50% of the time, and off for 50% of the time.

Adjustment of the set values:

- the values of time and range are read in the course of the relay's operation. The set values may be modified at any moment,
- it is possible to change the function during operation of the relay, which results in triggering operation with a new setting. It is not necessary to switch the supply off and on again for the relay to start operating with a new setting.

Triggering: depending on the function to be performed, the relay is triggered with the supply voltage or by connection of the S contact to the A1 line. For DC supply, the positive pole must be connected to the A1 line. The level of the S contact activation is adjusted automatically depending on the supply voltage.

Supply: the relay may be supplied with DC voltage or AC voltage 48...63 Hz of 10,8...264 V.

Connection diagram

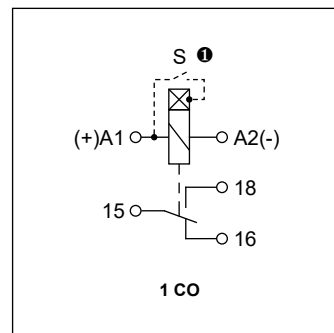

① The control terminal S is activated by connection to A1 terminal via the external control contact S.

RPC-1MC-UNI

time relays

Front panel description

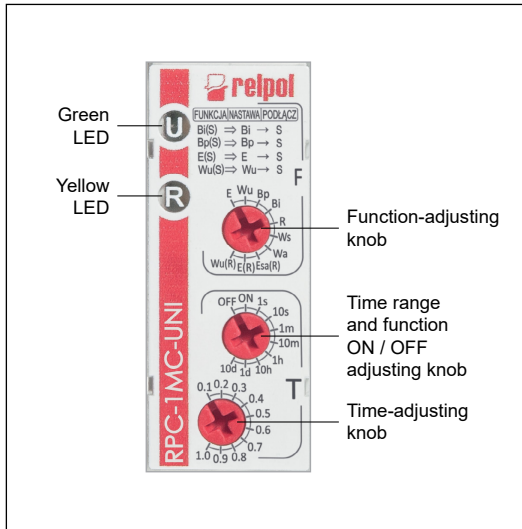

Dimensions

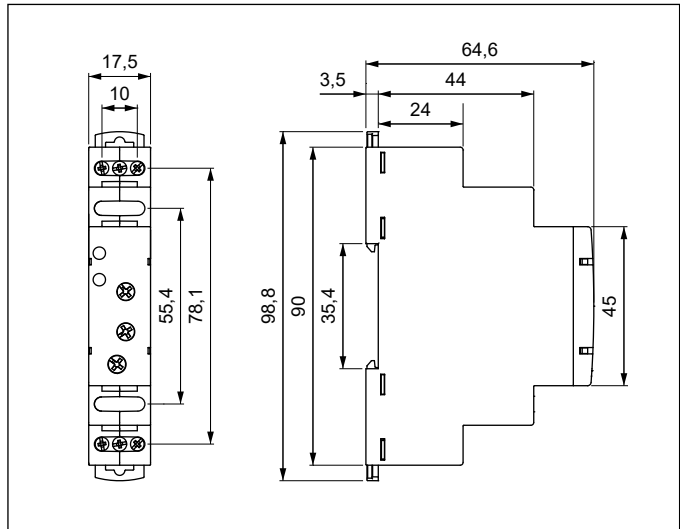

Mounting

Relays **RPC-1MC-UNI** are designed for direct mounting on 35 mm rail mount acc. to EN 60715. Operational position - any. **Connections:** max. cross section of the cables: 1 x 2,5 mm² (1 x 14 AWG), stripping length: 6,5 mm, max. tightening moment for the terminal: 0,5 Nm.

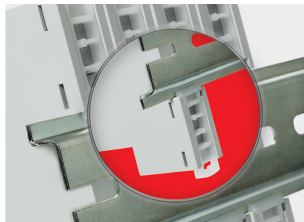

Two catches:
easy mounting
on 35 mm rail,
firm hold
(top and bottom).

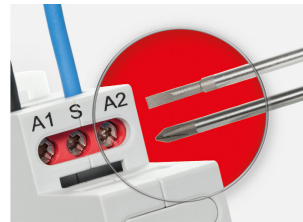

**Mounting wires
in clamps:**
universal screw
(cross-recessed
or slotted head).

Ordering codes

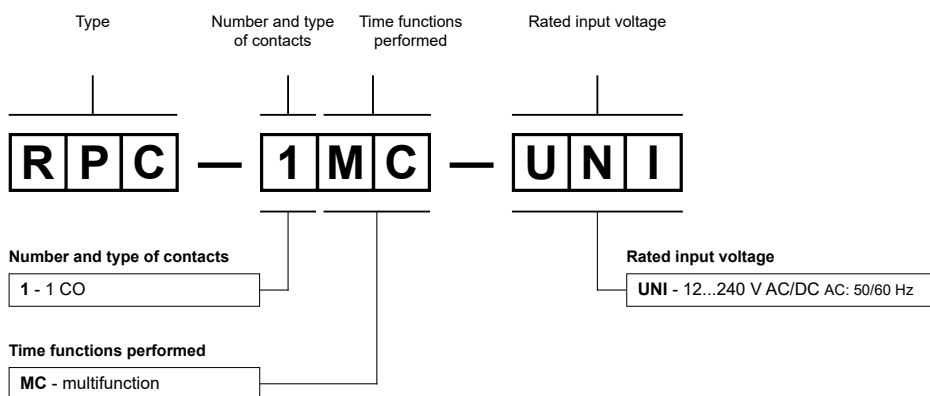

Example of ordering codes:

RPC-1MC-UNI

time relay **RPC-1MC-UNI**, multifunction (relay perform 14 functions), cover - modular, width 17,5 mm, one changeover contact, contact material AgSnO₂, rated input voltage 12...240 V AC/DC AC: 50/60 Hz

PRECAUTIONS:

1. Ensure that the parameters of the product described in its specification provide a safety margin for the appropriate operation of the device or system and never use the product in circumstances which exceed the parameters of the product. 2. Never touch any live parts of the device. 3. Ensure that the product has been connected correctly. An incorrect connection may cause malfunction, excessive heating or risk of fire. 4. In case of any risk of any serious material loss or death or injuries of humans or animals, the devices or systems shall be designed so to equip them with double safety system to guarantee their reliable operation.